

RETRO SL REAR VIEW

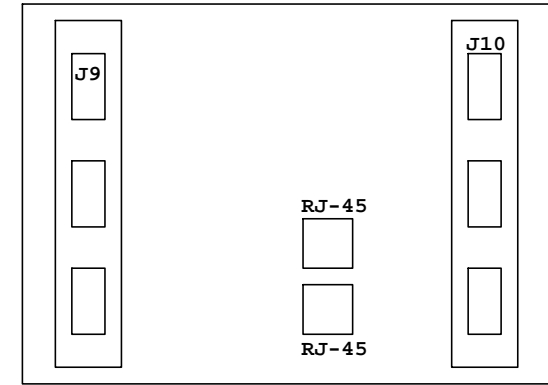
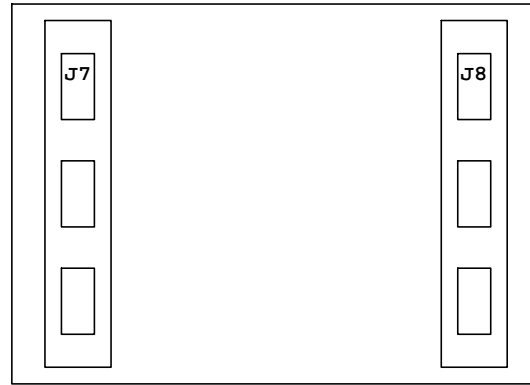
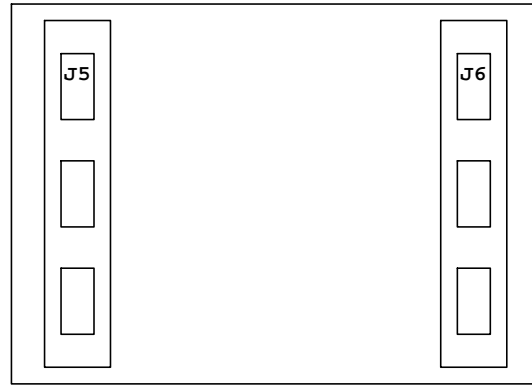
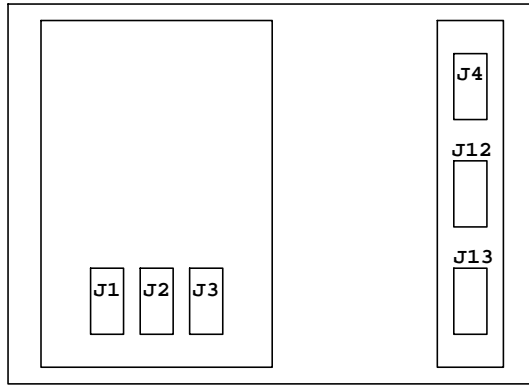

J1
DB9 Male
Function: 24V for TP-CT
Pin 2: GND
Pin 3: 24V

J2
DB9 Female
Function: CLOCK
Pin 1: GND
Pin 4: CLOCK+
Pin 5: CLOCK-

J3
DB9 Male
Function: TIMER
Pin 2: GND
Pin 9: START

J4
DB15 Male
Function: CUE POT

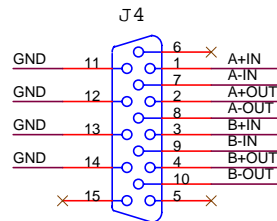

J5
DB9 Male
Function: 24V for METER 3 & 4 LIGHTS
Pin 2: GND
Pin 3: 24V

J6
DB9 Male
Function: AUDIO for METER 3 (LEFT) and 4 (RIGHT)
Pin 4: LEFT+
Pin 5: LEFT-
Pin 8: RIGHT+
Pin 9: RIGHT-

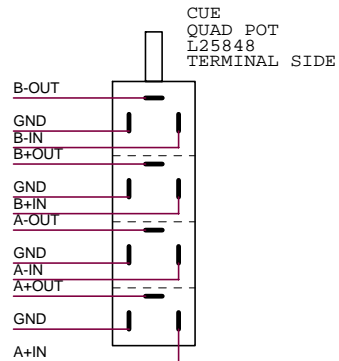

J12
DB9 Male
Function: SPEAKER POT
Pin 1: GND
Pin 2: WIPER
Pin 6: 5V

J13
DB9 Male
Function: HEADPHONE POT
Pin 1: GND
Pin 2: WIPER
Pin 6: 5V

J7
DB9 Male
Function: 24V for METER 1 & 2 LIGHTS
Pin 2: GND
Pin 3: 24V

J8
DB9 Male
Function: AUDIO for METER 1 (LEFT) and 2 (RIGHT)
Pin 4: LEFT+
Pin 5: LEFT-
Pin 8: RIGHT+
Pin 9: RIGHT-

J9
DB9 Male
Function: 24V for TIMER & TP-8
Pin 2: GND
Pin 3: 24V

J10
DB9 Male
Function: TIMER START & STOP
Pin 1: GND
Pin 2: GND
Pin 8: STOP
Pin 9: START

RJ-45s
Function: TP8 DATA (Use either RJ-45)
Pin 1: DATA+
Pin 2: DATA-

J11
NEUTRIK Ethernet RJ-45
Function: DATA for Modules

RJ-45 pin	T568B Standard	Color
1	PAIR 1+	WHITE-ORANGE
2	PAIR 1-	ORANGE
3	PAIR 2+	WHITE-GREEN
4	PAIR 3+	BLUE
5	PAIR 3-	WHITE-BLUE
6	PAIR 2-	GREEN
7	PAIR 4+	WHITE-BROWN
8	PAIR 4-	BROWN

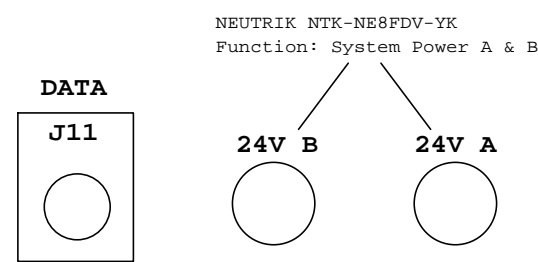

Sierra Automated Systems & Engineering Corp.

Title: **RETRO SL EXT WIRING - F.R.**

Size: B Document Number: _____ Rev: A

Date: Monday, February 12, 2007 Sheet 1 of 1